

dwin

167.001.01
167.001.02
167.001.03
167.001.04

metercube

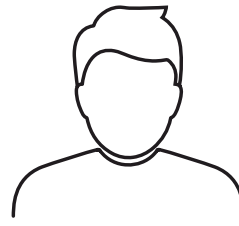
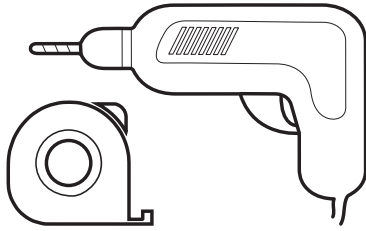

1x

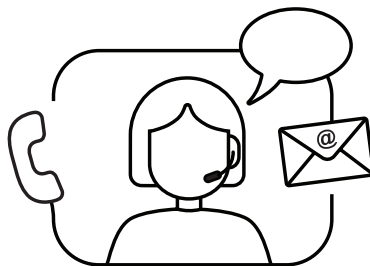
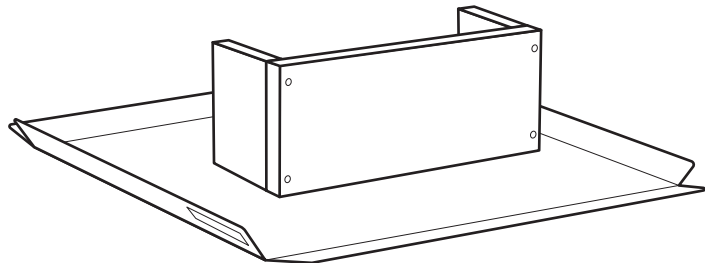
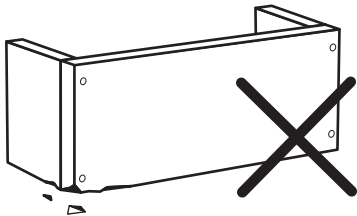
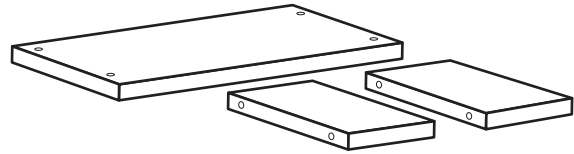
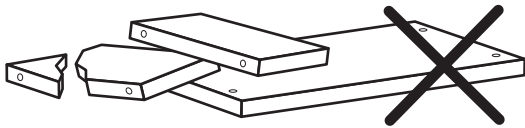

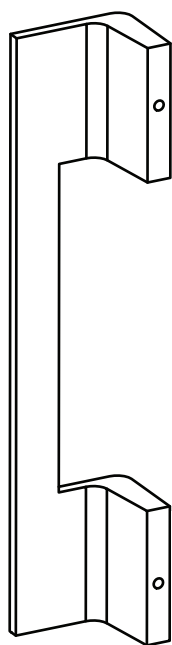

193304
193104
193004
193204

1x



540003

2x

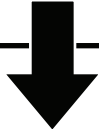
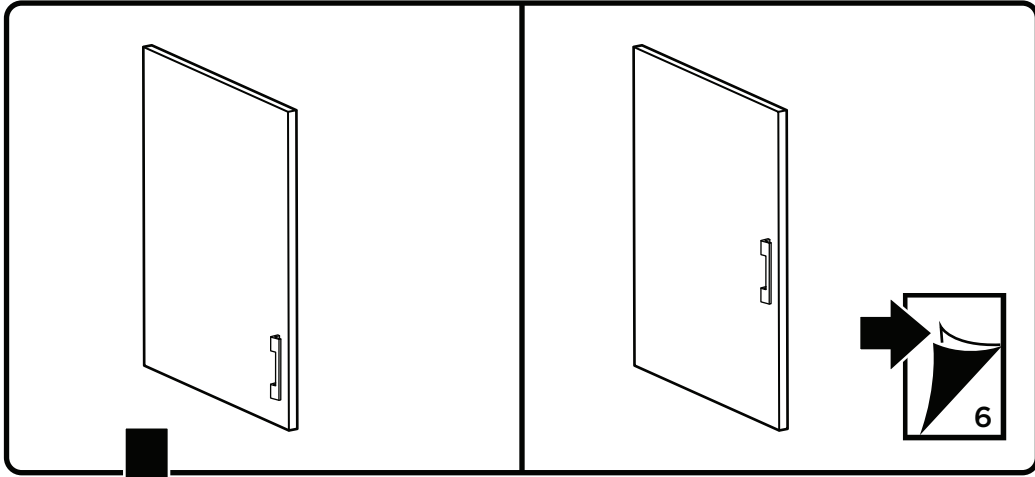

1

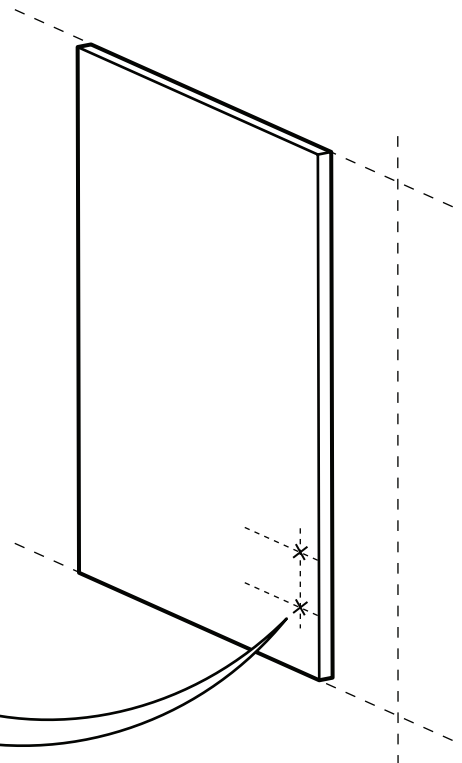
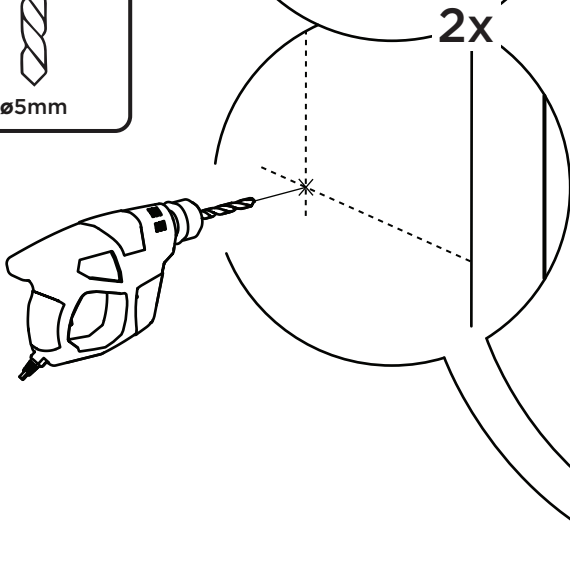
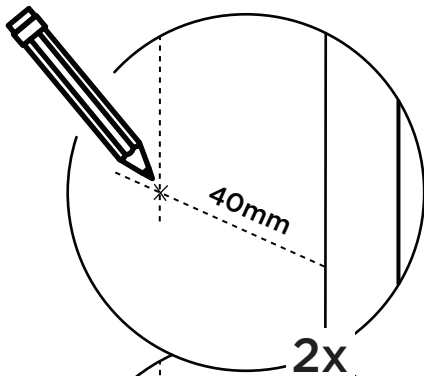
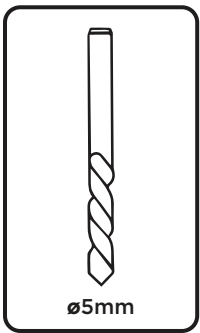
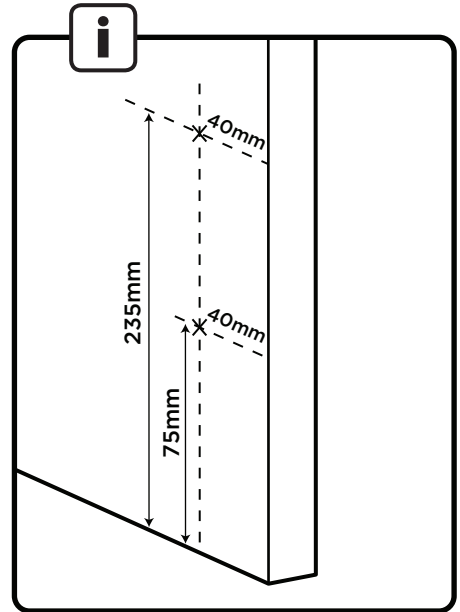

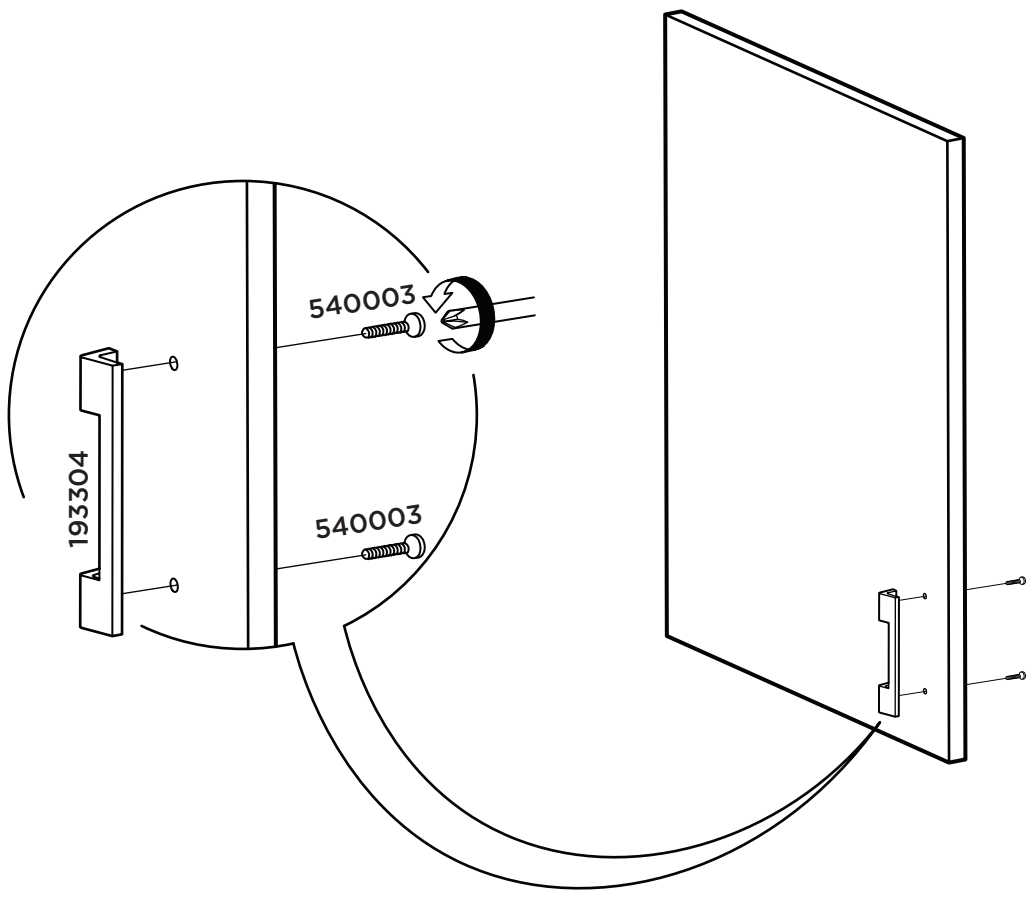

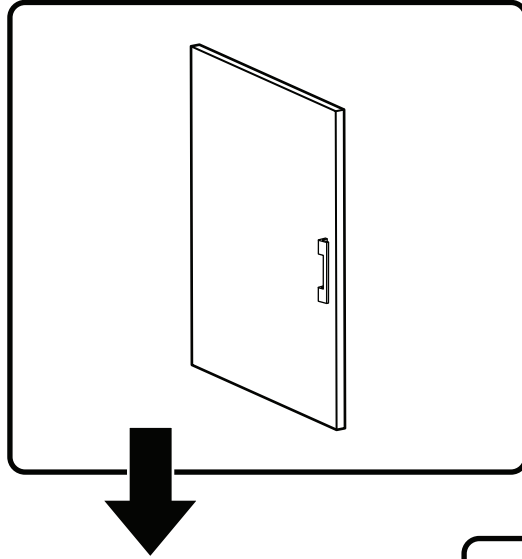

3

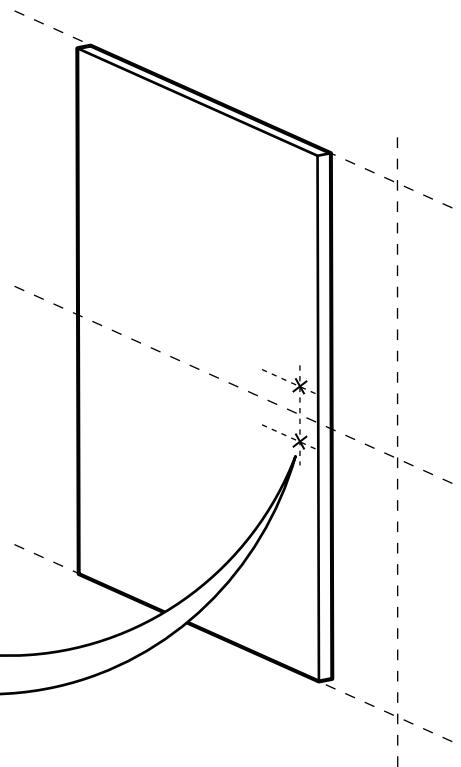
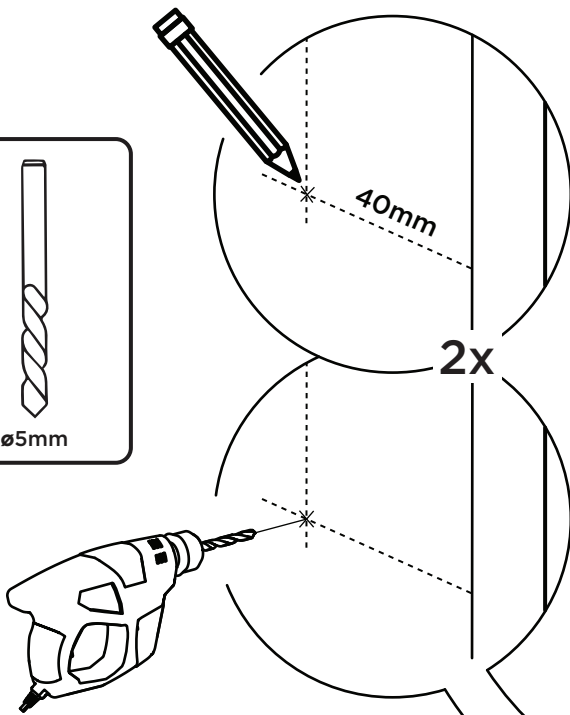
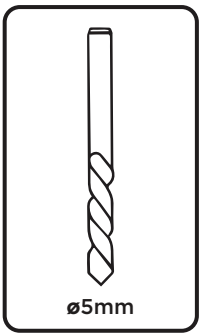
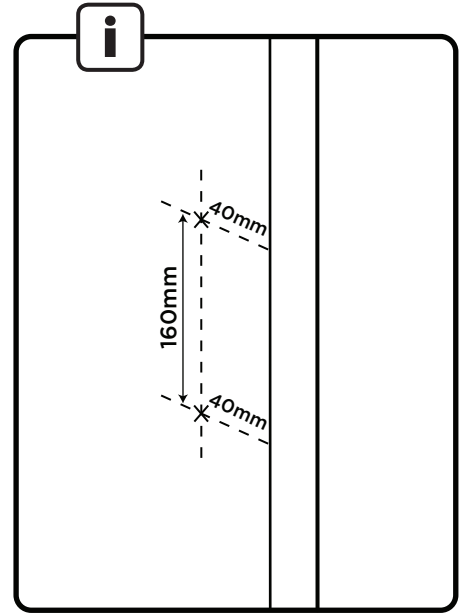

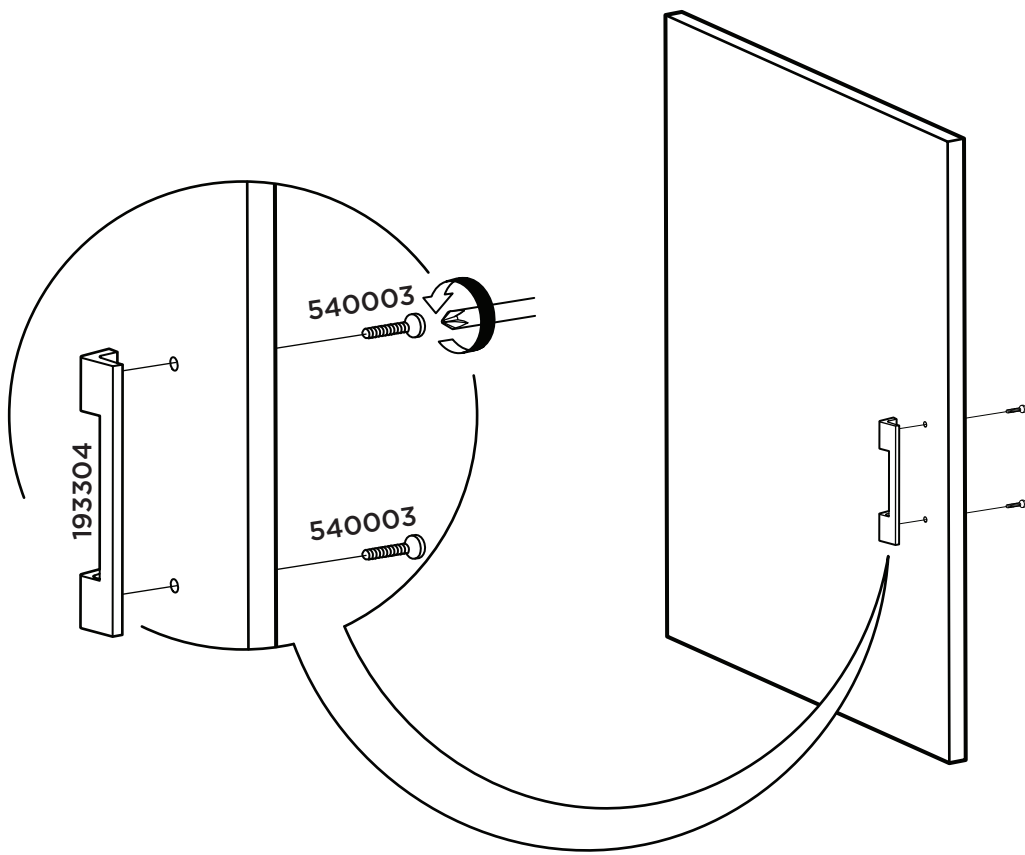

metercube